

## Datasheet

### MB102 Breadboard 3.3V/5V Power Supply

A 3.3V and 5V Breadboard Power Supply Module with series diode, polarity reversal protection. The module can take 6.5V to 12V input and can produce 3.3V and +5V. This is a must have power supply module for experimenters who have to test/prototype electronic circuits on breadboard or perforated/veroboards.



#### Brief Data:

- Plug directly to MB102 Standard breadboard.
- Input voltage: 6.5-12 V (DC) or 5V USB power supply.
- Output voltage: 3.3V and 5V can switch over.
- Maximum output current: <700 mA.
- External Input voltage ON/OFF switch.
- Independent control of upper and Lower Bread Board Power Rails. Can switch over to 0V, 3.3V, 5V using jumpers on any rail.
- On-board two groups of 3.3V, 5V DC output plug pin, convenient external lead use.
- USB device connector onboard for power output to external device.
- Size: 5.3cm x 3.5cm.

## Board Functional Block Diagram:

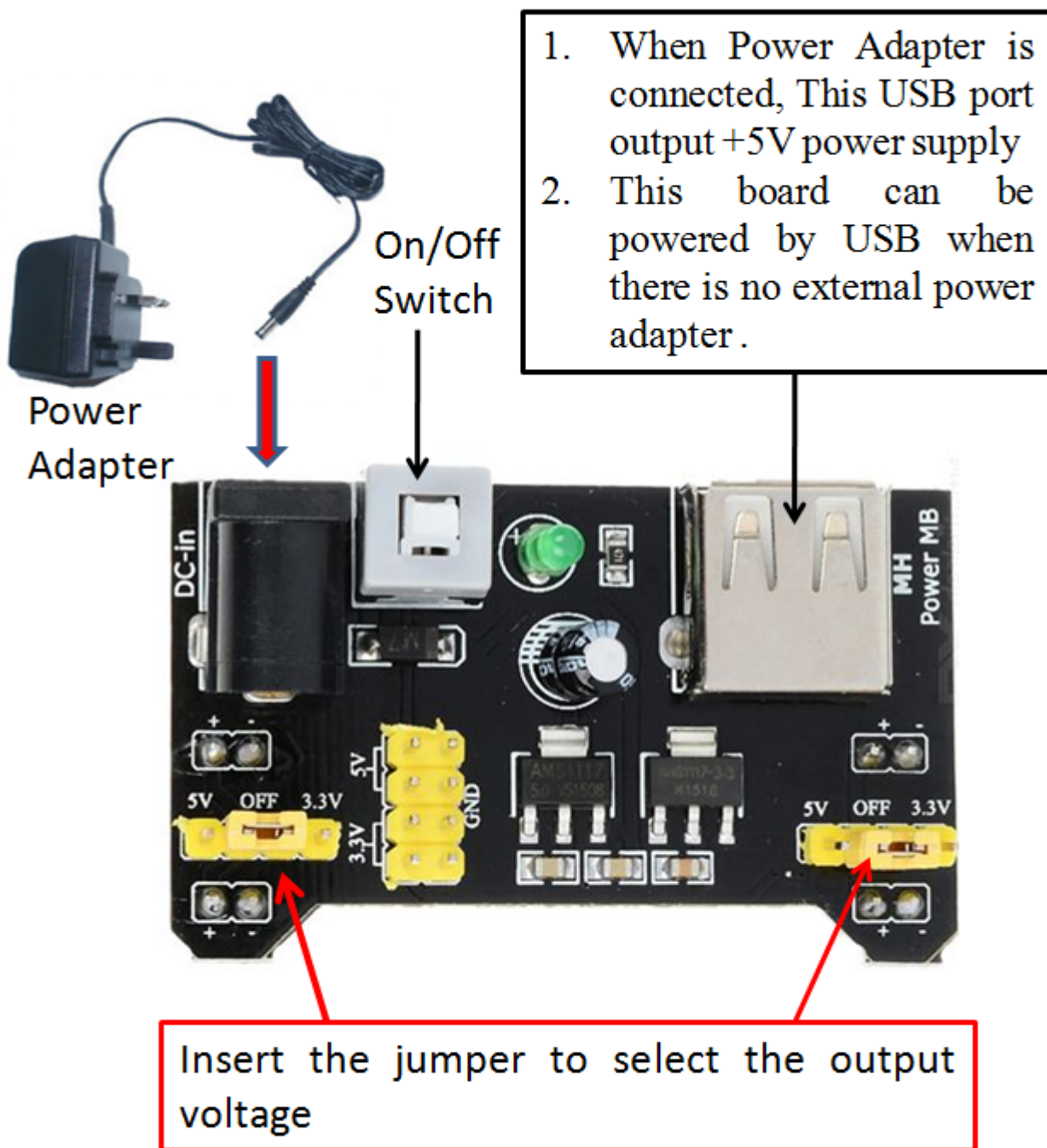

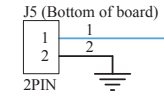
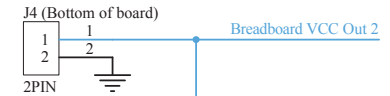
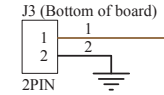
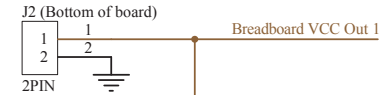
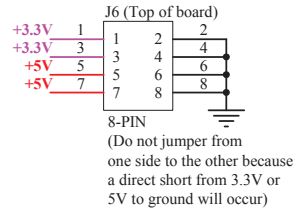
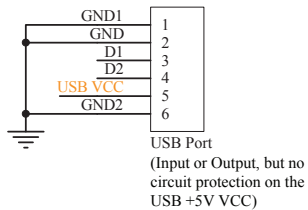
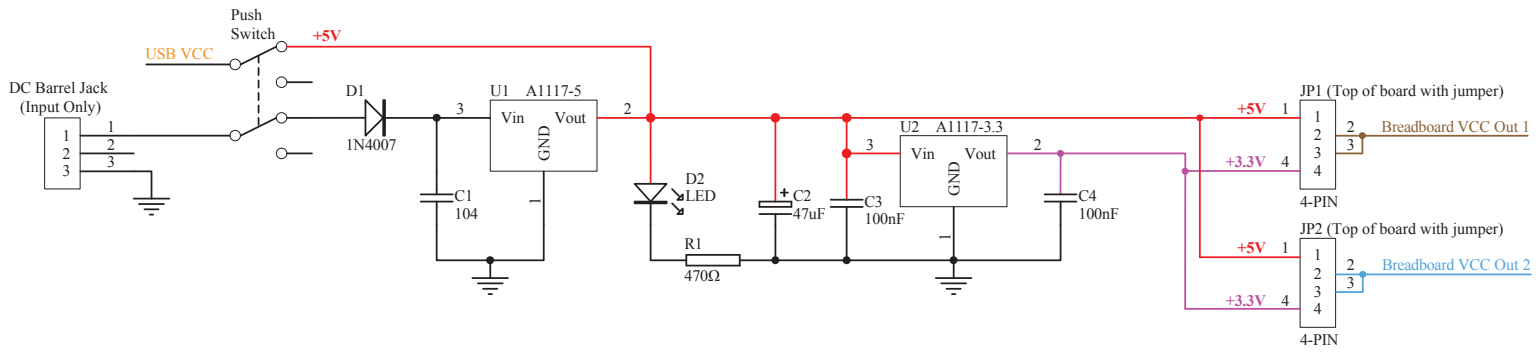

www.addicore.com

Title Addicore YwRobot Breadboard Power Supply Module		
Size	Number	Revision V2
Date:	1-January-2015	